

BALL VALVE

C 200

Nominal size DN 10–50

Nominal size 3/8"–2"

Nominal pressure PN 10–16 bar

Additional options on request

- Silicone free

www.asv-stuebbe.com/products/valves

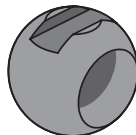

C 200

Characteristics C 200

- High-quality industrial valve
- Flexible modular system with wide range of variants
- Reliable material combinations for safe handling of critical medium types
- Newly designed ergonomic grip with position lock "Safety Guard"
- Intelligent accessories and interfaces for integration of limit switches and actuators
- Optional relief well for medium types prone to gas emission
- Integrated mounting bushing

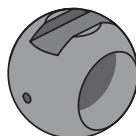

C 200 with relief well

Characteristics, C 200 with relief well

- Like characteristics of C200
- The relief well prevents pressure from being built up due to the medium in the ball of the closed valve unit
- For medium types prone to gas emission, e.g. H₂O₂, NaOCl
- Product range differing from C 200, see pictograph

Pictogram Ball valve C 200

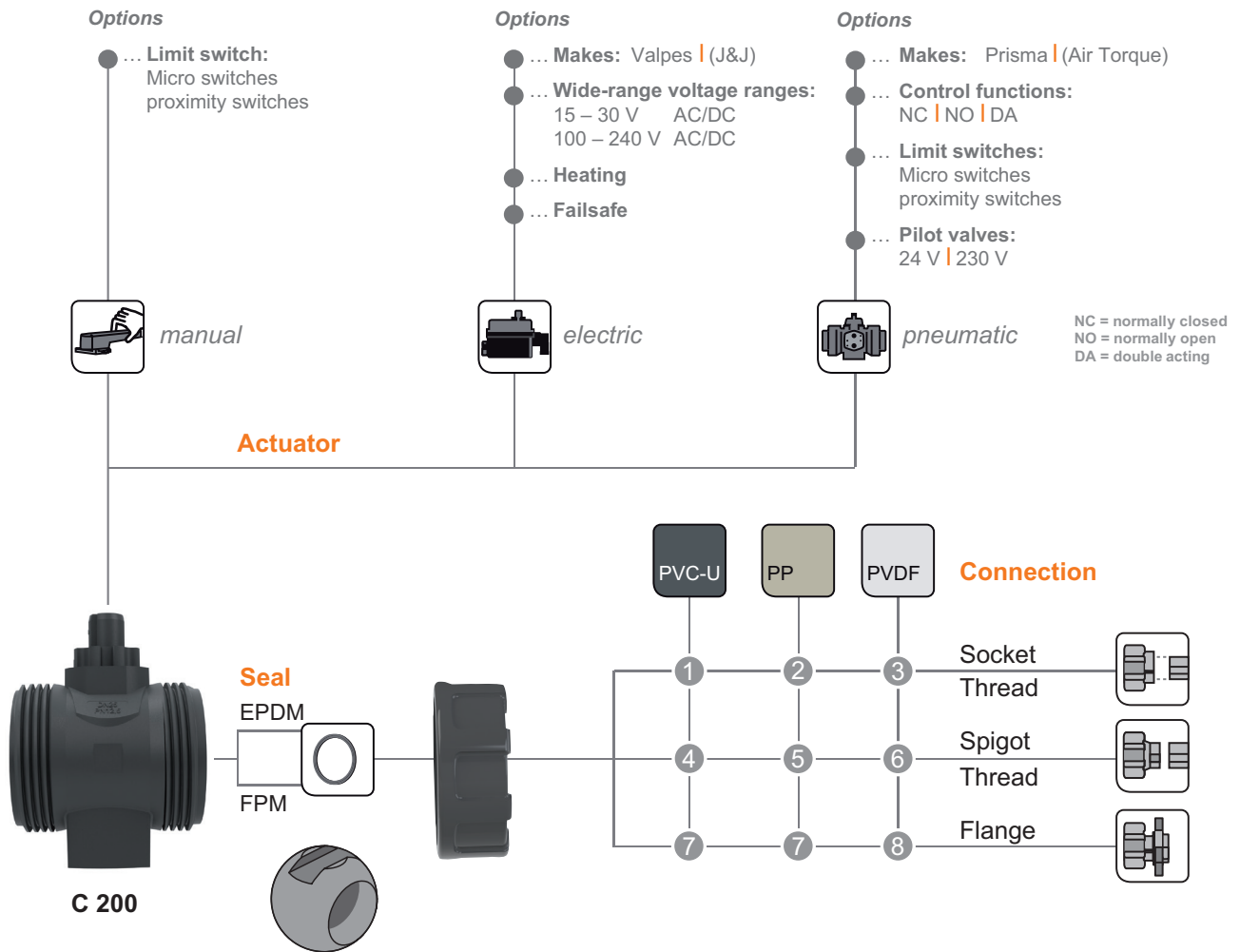

Basic nominal diameters:

DN 8	DN 10	DN 15	DN 20	DN 25	DN 32	DN 40	DN 50	DN 65	DN 80	DN 100	DN 125	DN 150	DN 200	DN 250	DN 300	DN 350	DN 400
------	-------	-------	-------	-------	-------	-------	-------	-------	-------	--------	--------	--------	--------	--------	--------	--------	--------

● available
○ not available

On request
» silicone free

Connection material (pipe connection)

1	PVC-U: socket DIN* Socket ANSI, BS, JIS Female thread Rp 1.4571 female thread Rp Male thread R 2.0401 female thread Rp Male thread R
2	PP socket DIN* Female thread Rp
3	PVDF socket DIN* * incl. DN 10

4	PE spigot (90 mm)
5	PP spigot IR PE spigot (90 mm)
6	PVDF spigot IR
7	PP/St. flange ANSI GFR flange DIN
8	PP/st. flange DIN, ANSI

Pictogra Ball valve C 200 with relief well

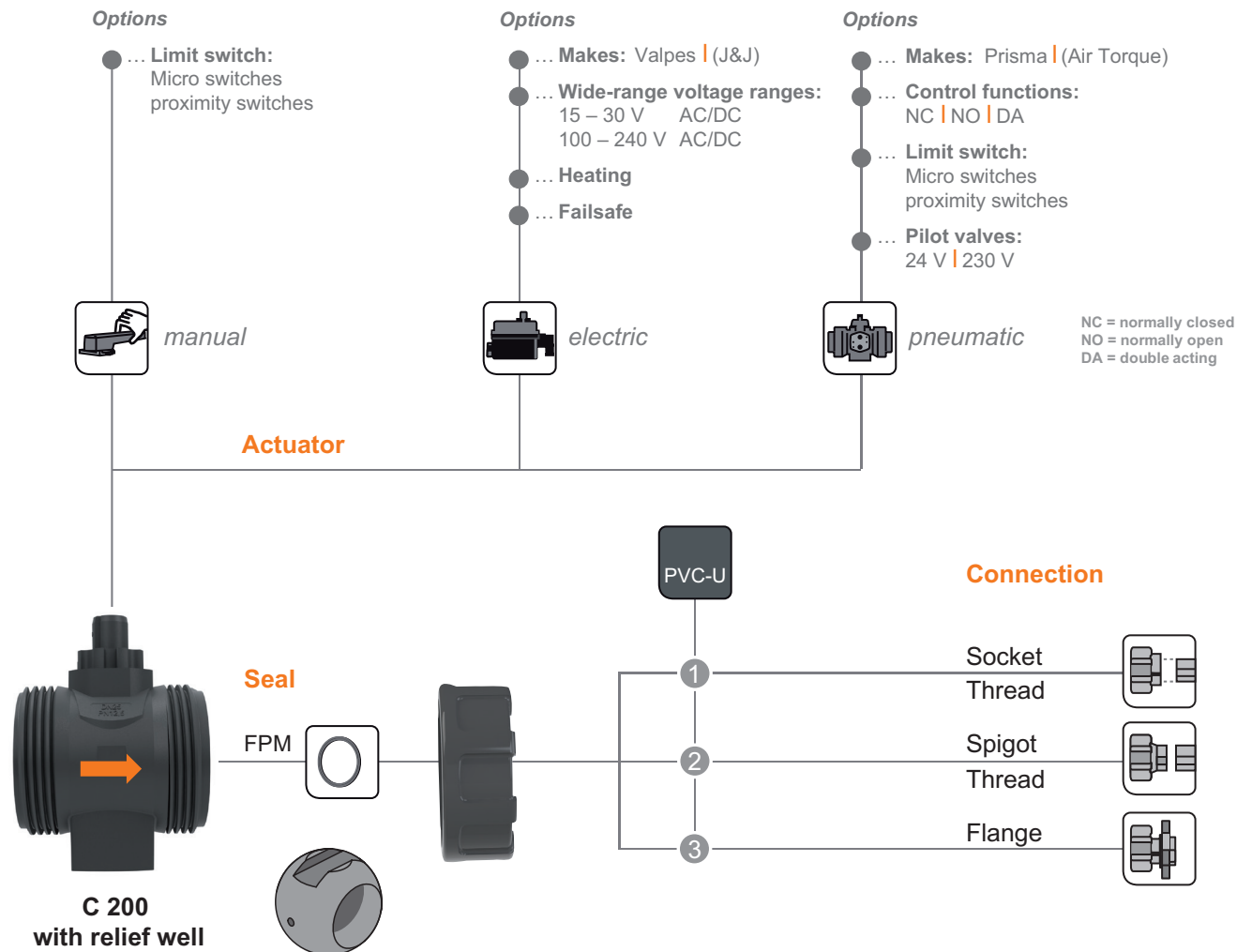

Basic nominal diameters:

DN 8	DN 10	DN 15	DN 20	DN 25	DN 32	DN 40	DN 50	DN 65	DN 80	DN 100	DN 125	DN 150	DN 200	DN 250	DN 300	DN 350	DN 400
------	-------	-------	-------	-------	-------	-------	-------	-------	-------	--------	--------	--------	--------	--------	--------	--------	--------

● available
○ not available

On request
» silicone free

Connection material (pipe connection)

① PVC-U socket DIN*
Socket ANSI, BS, JIS
Female thread Rp
1.4571 female thread Rp
Male thread R

② PE spigot (90 mm)

③ PP/St. flange ANSI
GFR flange DIN

* incl. DN 10

Ball valve C 200

Use

- Chemical and industrial plant engineering

Application

- Valve for shutting off pipeline systems

Flow medium

- Neutral and aggressive fluid or gaseous media free of solid particles, provided that the valve components coming into contact with the media are resistant at the operating temperature in accordance with the ASV resistance guide.

ASV resistance guide

- www.asv-stuebbe.de/pdf_resistance/300051.pdf

Testing

- Requirements and testing according to DIN EN ISO 16135 and ISO 9393
- Leakage rate A tested according to DIN EN 12266

Nominal pressure (H₂O, 20 °C)

- PN 10–16 bar

Medium temperature

- see pressure/temperature diagram

Operating pressure

- see pressure/temperature diagram

Size

- DN 10–50

Housing

C 200:

- PVC-U, PP, PVDF

C 200 with relief well:

- PVC-U

Ball

C 200:

- PVC-U, PP, PVDF

C 200 with relief well:

- PVC-U

Ball pivot

C 200:

- PVC-U, PP glass fibre reinforced, PVDF

C 200 with relief well:

- PVC-U

Ball seat

- PTFE

Sealing, O-ring

C 200:

- FPM, EPDM

C 200 with relief well:

- FPM

Actuation

- manual: with lockable hand lever for the »OPEN«- or »CLOSED« position (basic valve)
- electric: with electric actuator, DIN EN ISO 5211 (additional option)
- pneumatic: with pneumatic actuator, DIN EN ISO 5211 (additional option)

Connection

- Union nut with connection thread suitable for plastic materials

Fastening

- via two threaded inserts (Ensate inserts) in the mounting base

Mounting position

- as required

Basic valve colour

- Housing: PVC-U, grey, RAL 7011
- Housing: PP, grey, RAL 7032
- Housing: PVDF, opaque, yellowish-white
- Hand lever: ABS, black, RAL 9005
- Hand lever inlay: ABS, orange, RAL 2004

Device connection

- see pictogram

Additional options

- Limit switch box
- Electric actuator Valpes
- Electric actuator J+J
- Pneumatic actuator Prisma
- Pneumatic actuator Air Torque

Accessories

- Manually actuated limit switch box
- Retrofitting set for automatic valves
- Pilot solenoid valve VS2

Ball valve C 200

Pressure/temperature diagram

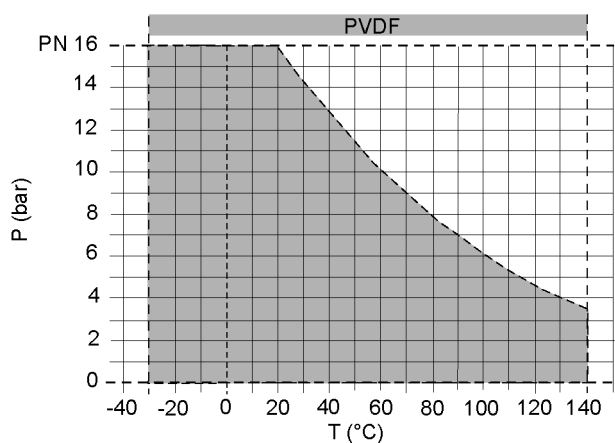
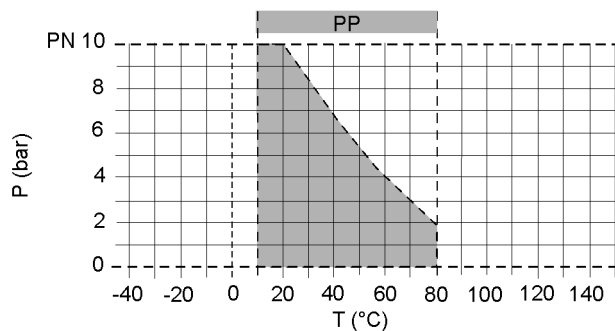
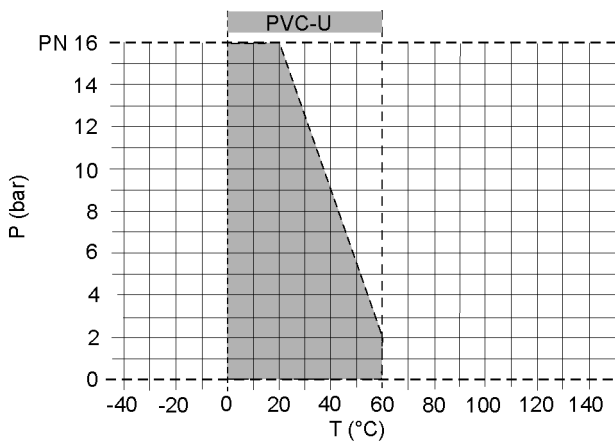

The pressure/temperature limits of the materials are valid for the stated nominal pressures and a service life of 25 years. These values are guide values for flow medium types which do not negatively impact the physical and chemical characteristics of the valve material. It may be necessary to take diminution factors into consideration. The operating life of the wear parts depends on the conditions of use.

Description

P	Operating pressure
T	Temperature

Ball valve C 200

Pressure loss curve (standard values for H₂O, 20 °C)

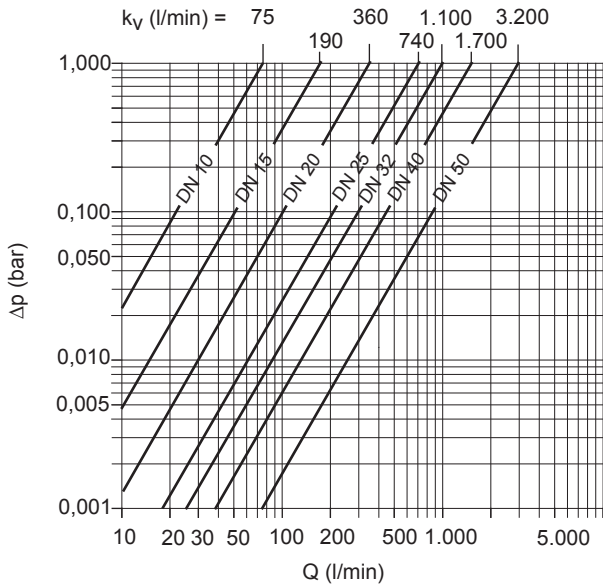

Description	
Δp	Pressure loss
Q	Flow

Flow characteristic

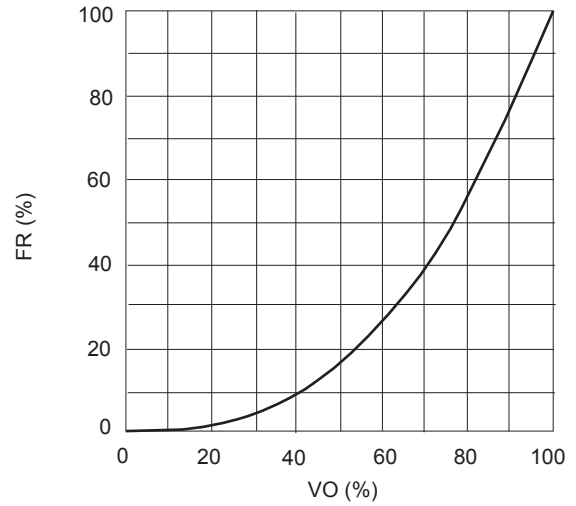

Description	
FR	k_v value (flow rate)
VO	Valve opening

Pressure loss and k_v value

The diagram shows the pressure loss Δp in relation to the flow Q .

Conversion formulas

$$c_v = k_v \times 0.07$$

$$f_v = k_v \times 0.0585$$

Units:

k_v [l/min]

c_v [gal/min] US

f_v [gal/min] GB

Ball valve C 200

with hand lever

Connection, PE spigot/socket

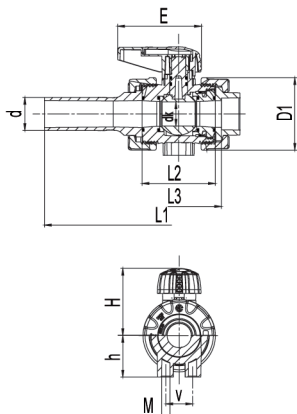

Connection, PP-(PVDF)-spigot/flange

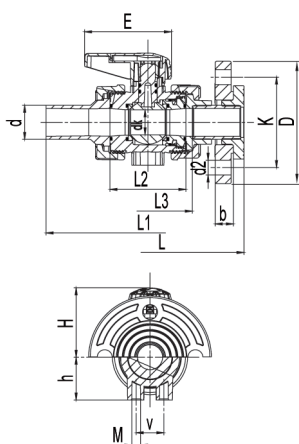

Connection female thread/male thread

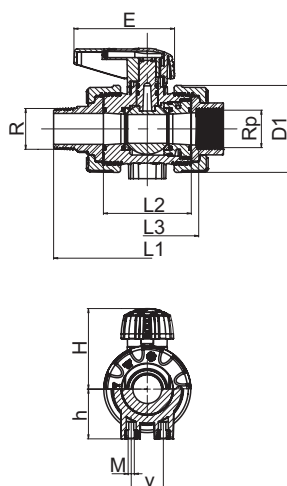

Basic valve dimensions

d (mm)	16	20	25	32	40	50	63		
DN (mm)	10	15	20	25	32	40	50		
DN (inch)	3/8	1/2	3/4	1	1 1/4	1 1/2	2		
Dimension	Housing material		Union end variant						
b	PVDF	PP/St. flange DIN	-	13	14.5	15.5	17.5	17.5	19
	PP / PVC-U	GFR flange DIN	-	12	14	15	17	17	18.5
	PP / PVC-U / PVDF	PP/St. flange ANSI	-	12	12	16	16	18	18
d2	PVDF	PP/St. flange DIN	-	14	14	14	18	18	18
	PP / PVC-U	GFR flange DIN	-	14	14	14	18	18	18
	PP / PVC-U / PVDF	PP/St. flange ANSI	-	16	16	16	16	16	20
D	PVDF	PP/St. flange DIN	-	96	106	116	141	151	166
	PP / PVC-U	GFR flange DIN	-	96.5	106	115	142	152	168
	PP / PVC-U / PVDF	PP/St. flange ANSI	-	95	105	113	130	133	160
D1	PP / PVC-U / PVDF		50.5	50.5	59	70.5	86	99.5	126
E			66.5	66.5	81.5	81.5	91.5	91.5	143
h			27	27	30	40	46	55	70
H	PP / PVC-U / PVDF		48	48	57	65	83.5	89.5	115
K	PVDF	PP/St. flange DIN	-	65	75	85	100	110	125
	PP / PVC-U	GFR flange DIN	-	65	75	85	100	110	125
	PP / PVC-U / PVDF	PP/St. flange ANSI	-	60	70	80	89	98	121
L	PP / PVC-U / PVDF	PP/St. flange DIN/ANSI	-	150	170	180	210	230	278
		GFR flange DIN							
L1	PVDF	PVDF spigot	-	130	143	150	171.5	191.5	220
		PP spigot	-	131	143.5	152	172	192	222
	PVC-U	PE spigot	-	236.5	245	251	265.5	269	281
		PE spigot	-	236	245	251	265	269	281
		Male thread R 1,4571 / 2,0401	-	125	138	151.5	178	185	212
L2	PVDF	-	56	56	65	71	85.5	89.5	101
	PP	-	56.5	56.5	65	71	85.5	89	101
	PVC-U	-	56	56	65	71	85	89	101
L3	PVDF	PVDF socket DIN	66.5	66	77	83	99.5	105.5	117
		PP socket DIN	67	67	77	83	100	106	117
	PVC-U	PP female thread Rp	-	63.5	72	81	99	106	117
		PVC-U socket DIN	64	63	72	79	94	96	108
		PVC-U socket ANSI	-	63	72	79	94	96	108
		PVC-U socket BS	-	62	71	77	91	95	107
		PVC-U socket JIS	-	62	71	77	91	96.5	107
		PVC-U female thread Rp	-	63	72	79	94	96	108
		1,4571/2,0401-Female thread Rp	-	63	72	79	94	96	108
		M	PP / PVC-U / PVDF		M5	M5	M5	M6	M8
R		1,4571/2,0401-Male thread R	-	1/2	3/4	1	1 1/4	1 1/2	2
Rp		1,4571/2,0401/PP/PVC-U-Female thread Rp	-	1/2	3/4	1	1 1/4	1 1/2	2
v	PP / PVC-U / PVDF		25	25	25	26	45	45	45

Additional options Ball valve C 200

Limit switch box

Limit switch box

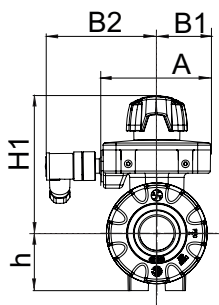
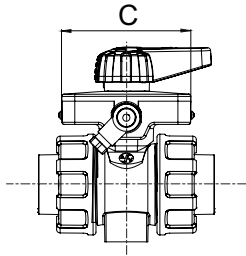

Plug assignment plug connector X



Limit switch box dimensions

d (mm)	16	20	25	32	40	50	63
DN (mm)	10	15	20	25	32	40	50
DN (inch)	3/8	1/2	3/4	1	1 1/4	1 1/2	2
A	72.0	72.0	77.0	77.0	89.0	89.0	92.5
B1	36.0	36.0	38.0	38.0	44.5	44.5	46.0
B2	75.0	75.0	78.0	78.0	82.5	82.5	84.0
C	87.0	87.0	92.0	92.0	108.0	108.0	112.5
h	27.0	27.0	30.0	40.0	46.0	55.0	70.0
H1	79.0	79.0	88.0	96.0	118.0	124.0	157.0

Micro switch type DC1C

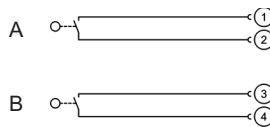

Switch type	DC1C
Switched voltage	≤ 250 V
Switching current	6 A (250 V AC); 3 A (24 V DC)
Contact material	AgNi
Type of protection	IP67

Inductive proximity switch type NBB2-V3-E2

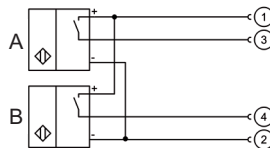

Switch type	NBB2-V3-E2
Switching function	PNP NO
Operating voltage	10–30 V DC
Load current	≤ 100 mA
Idle current	≤ 15 mA
Type of protection	IP67

Inductive proximity switch type NJ2-V3-N

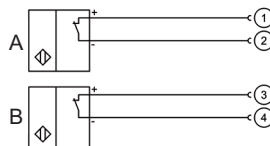

Switch type	NJ2-V3-N
Switching function	Namur
Nominal voltage	8.2 V
Current consumption (end position detected)	≤ 1 mA
Current consumption (end position not detected)	≥ 3 mA
Type of protection	IP67

	Description
A	Connection »CLOSED«
B	Connection »OPEN«

Additional options Ball valve C 200

Electric actuator with basic valve

Valpes actuator

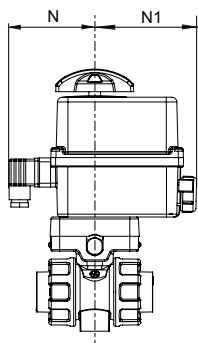

Valpes actuator dimensions

d (mm)	16	20	25	32	40	50	63
DN (mm)	10	15	20	25	32	40	50
DN (inch)	3/8	1/2	3/4	1	1 1/4	1 1/2	2
h	27.0	27.0	30.0	40.0	46.0	55.0	70.0
h1	63.5	63.5	69.0	77.0	86.5	92.5	108.0
H	152.0	152.0	152.0	152.0	152.0	152.0	152.0
N	88.0	88.0	88.0	88.0	88.0	88.0	88.0
N1	105.0	105.0	105.0	105.0	105.0	105.0	105.0
O	92.0	92.0	92.0	92.0	92.0	92.0	92.0

J&J actuator dimensions

d (mm)	16	20	25	32	40	50	63
DN (mm)	10	15	20	25	32	40	50
DN (inch)	3/8	1/2	3/4	1	1 1/4	1 1/2	2
h	27.0	27.0	30.0	40.0	46.0	55.0	70.0
h1	63.5	63.5	69.0	77.0	86.5	92.5	108.0
H	148.0	148.0	148.0	148.0	148.0	148.0	148.0
N	51.0	51.0	51.0	51.0	51.0	51.0	51.0
N1	130.0	130.0	130.0	130.0	130.0	130.0	130.0
O	110.0	110.0	110.0	110.0	110.0	110.0	110.0

J&J actuator

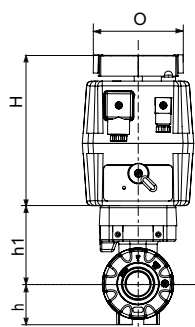
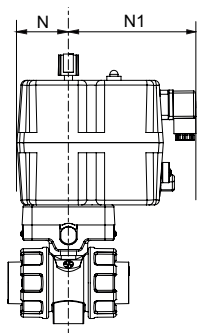

Note

Electric actuators may not be installed in an over-head position!

Ball valve C 200

Electric actuator Valpes

Technical data

Manufacturer: Valpes ER

Actuator type	ER 20 Premier without options		ER 20 Plus incl. heater, extendible	
	Low voltage	Mains voltage	Low voltage	Mains voltage
Torque (Nm)	20	20	20	20
Voltage AC (V)	24	90–240	15–30	100–240
Voltage DC (V)	24	90–350	12–48	100–350
Manipulating time (s)	13	13	12	12
Setting angle (°)	90	90	90	90
Power consumption (W)	15	15	15	15
Weight (kg)	1	1	1	1
Duty cycle (%)	30	30	50	50
Protection type (IP)	65	65	66	66
Temperature (°C)	-10–55	-10–55	-10–55	-10–55
Heating	not available	not available	Included	Included
Options	not available	not available	Fail-Safe/ rechargeable battery pack	Fail-Safe/ rechargeable battery pack

Voltage supply

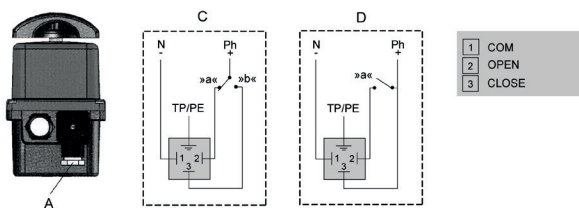

	Description
A	Voltage supply
C	3-point mode
D	OPEN-CLOSED mode
a	Valve »OPEN«
b	Valve »CLOSED«
1	COM
2	Valve »OPEN«
3	Valve »CLOSED«

Feedback

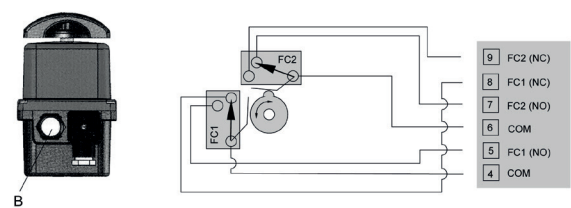

	Description
B	Feedback
FC1	Limit switch, valve »OPEN«
FC2	Limit switch, valve »CLOSED«
9	FC2 (NC)
8	FC1 (NC)
7	FC2 (NO)
6	COM
5	FC1 (NO)
4	COM

Ball valve C 200

Electric actuator J&J

Technical data

Manufacturer: J&J

Actuator type	J3 incl. heater, extendible	
	Low voltage	Mains voltage
Torque (Nm)	20	20
Voltage AC (V)	12-24	85-240
Voltage DC (V)	12-24	85-240
Manipulating time (s)	12	11
Setting angle (°)	90	90
Power consumption (W)	26	110V-19W; 230V-44W
Weight (kg)	1.8	1.8
Duty cycle (%)	75	75
Protection type (IP)	65	65
Temperature (°C)	-20-70	-20-70
Heating	Yes	Yes
Options	Fail-Safe/rechargeable battery pack	Fail-Safe/rechargeable battery pack

Voltage supply AC/DC

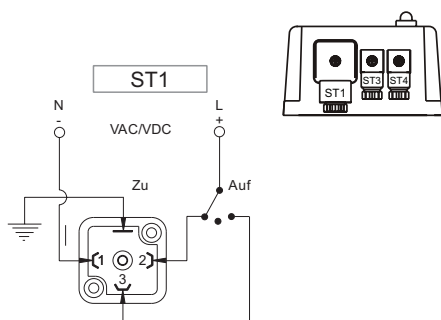

Description	
1	Connection of the neutral conductor (N/-)
2	Connection of phase (L/+) »CLOSED«
3	Connection of phase (L/+) »OPEN«

Limit switches, external and internal

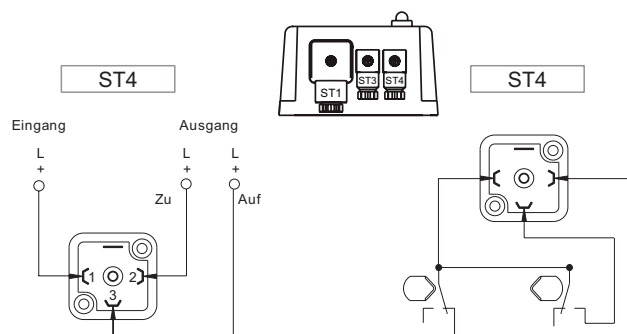

Description	
1	Connection of the voltage input (+/L)
2	Connection of the limit switch output (+/L) »CLOSED«
3	Connection of the limit switch output (+/L) »OPEN«

Additional options Ball valve C 200

Pneumatic actuator with basic valve

Prisma actuator

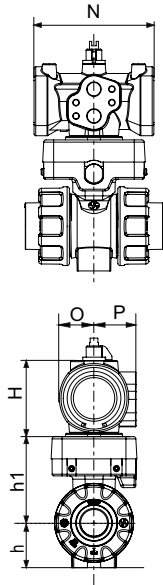

Prisma actuator dimensions

d (mm)	16	20	25	32	40	50	63
DN (mm)	10	15	20	25	32	40	50
DN (inch)	3/8	1/2	3/4	1	1 1/4	1 1/2	2
Actuator type	DA	PPW	PPW	PPW	PPW	PP00	PP00
	NC/NO	PPWS	PPWS	PPWS	PPWS	PP00S	PP10S
h	27.0	27.0	30.0	40.0	46.0	55.0	70.0
h1	63.5	63.5	69.0	77.0	86.5	92.5	108.0
H	DA	85.0	85.0	88.0	88.0	114.0	114.0
	NC/NO	85.0	85.0	88.0	88.0	114.0	123.0
N	DA	107.0	107.0	107.0	107.0	125.0	125.0
	NC/NO	142.0	142.0	142.0	142.0	155.0	230.5
O	DA	31.0	31.0	31.0	31.0	36.0	36.0
	NC/NO	31.0	31.0	31.0	31.0	36.0	40.0
P	DA	37.5	37.5	37.5	37.5	44.0	44.0
	NC/NO	37.5	37.5	37.5	37.5	44.0	57.0

Air Torque actuator

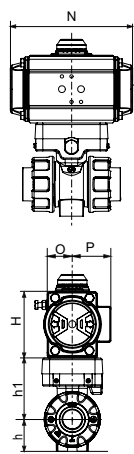

Air Torque actuator dimensions

d (mm)	16	20	25	32	40	50	63
DN (mm)	10	15	20	25	32	40	50
DN (inch)	3/8	1/2	3/4	1	1 1/4	1 1/2	2
Actuator type	DA	DR15	DR15	DR15	DR30	DR30	DR30
	NC/NO	SC15-6	SC15-6	SC15-6	SC30-6	SC30-6	SC30-6
h	27.0	27.0	30.0	40.0	46.0	55.0	70.0
h1	63.5	63.5	69.0	77.0	86.5	92.5	108.0
H	89.0	89.0	89.0	105.0	105.0	105.0	122.0
N	136.0	136.0	136.0	153.5	153.5	153.5	203.5
O	29.0	29.0	29.0	36.0	36.0	36.0	42.5
P	40.0	40.0	40.0	48.5	48.5	48.5	50.5

Mounting box

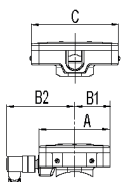

Mounting box dimensions

d (mm)	16	20	25	32	40	50	63
DN (mm)	10	15	20	25	32	40	50
DN (inch)	3/8	1/2	3/4	1	1 1/4	1 1/2	2
A	72.0	72.0	77.0	77.0	89.0	89.0	92.5
B1	36.0	36.0	38.0	38.0	44.5	44.5	46.0
B2	75.0	75.0	78.0	78.0	82.5	82.5	84.0
C	87.0	87.0	92.0	92.0	108.0	108.0	112.5

Additional options Ball valve C 200

Pneumatic actuator Prisma

Technical data

Manufacturer: Prisma PP-Line

Actuator type	PPWS	PPooS	PP1oS
Function	NC/NO	NC/NO	NC/NO
Torque start at 6 bar (Nm)	10.4	15.9	46.6
Torque end at 6 bar (Nm)	6.5	11.3	32.3
Control volume, opening (litres)	0.08	0.15	0.35
Manipulating time, opening (s)	0.15	0.2	0.3
Manipulating time, closing (s)	0.15	0.2	0.3
Control pressure connection (inch)	G 1/4	G 1/4	G 1/4
Weight (kg)	0.47	1.03	2.15
Options	Limit switches	Limit switches	Limit switches
Options	Pilot valve VS2	Pilot valve VS2	Pilot valve VS2

Actuator type	PPW	PPoo
Function	DA	DA
Torque start at 6 bar (Nm)	17.0	25.0
Torque end at 6 bar (Nm)	0.08	0.15
Control volume, opening (litres)	0.05	0.1
Manipulating time, opening (s)	0.1	0.15
Manipulating time, closing (s)	0.1	0.15
Control pressure connection (inch)	G 1/4	G 1/4
Weight (kg)	0.33	0.76
Options	Limit switches	Limit switches
Options	Pilot valve VS2	Pilot valve VS2

Control pressure connection

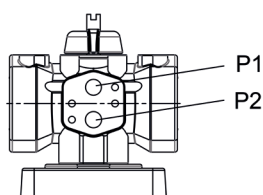

Function	Control pressure open	
	Connection P1	Connection P2
Normally closed (NC)		»OPEN«
Normally open (NO)		»CLOSED«
Double-acting (DA)	»CLOSED«	»OPEN«

Control

- 3/2-way solenoid valves for NC/NO actuators
- 5/2-way solenoid valves for DA actuators

Note

The actuators require a control pressure of 6 bar for optimum function. Malfunctions may occur, if the control pressure deviates. In this case, a new actuator configuration is necessary.

Ensure that the control medium is free of dust and oil. Ensure that the maximum particle size does not exceed 30 µm (ISO 8573 Part 1, Class 5). To prevent water condensation and/or formation of ice (at work temperatures under 0°C), ensure that the medium has a dew point of -20°C or at least 10°C below the ambient temperature (ISO 8573 Part 1, Class 3).

Additional options Ball valve C 200

Pneumatic actuator Air Torque

Technical data

Manufacturer: Air Torque DR/SC

Actuator type	SC15-6	SC30-6	SC60-6
Function	NC/NO	NC/NO	NC/NO
Torque start at 6 bar (Nm)	13.3	21.9	43.3
Torque end at 6 bar (Nm)	9.3	14.9	28.3
Control volume, opening (litres)	0.09	0.16	0.31
Manipulating time, opening (s)	0.25	0.30	0.40
Manipulating time, closing (s)	0.30	0.35	0.50
Control pressure connection (inch)	G 1/8	G 1/8	G 1/8
Weight (kg)	1.22	1.85	3.04
Options	Limit switches	Limit switches	Limit switches
Options	Pilot valve VS2	Pilot valve VS2	Pilot valve VS2

Actuator type	DR15	DR30	DR60
Function	DA	DA	DA
Torque at 6 bar (Nm)	19.9	35.2	69.8
Control volume, opening (litres)	0.09	0.16	0.31
Manipulating time, opening (s)	0.20	0.25	0.30
Manipulating time, closing (s)	0.25	0.30	0.35
Control pressure connection (inch)	G 1/8	G 1/8	G 1/8
Weight (kg)	1.1	1.16	2.68
Options	Limit switches	Limit switches	Limit switches
Options	Pilot valve VS2	Pilot valve VS2	Pilot valve VS2

Control pressure connection

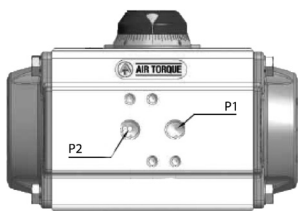

Function	Control pressure open	
	Connection P1	Connection P2
Normally closed (NC)		»OPEN«
Normally open (NO)		»CLOSED«
Double-acting (DA)	»CLOSED«	»OPEN«

Note

The actuators require a control pressure of 6 bar for optimum function. Malfunctions may occur, if the control pressure deviates. In this case, a new actuator configuration is necessary. Ensure that the control medium is free of dust and oil. Ensure that the maximum particle size does not exceed 30 µm (ISO 8573 Part 1, Class 5). To prevent water condensation and/or formation of ice (at work temperatures under 0°C), ensure that the medium has a dew point of -20°C or at least 10°C below the ambient temperature (ISO 8573 Part 1, Class 3).

Rotation limit

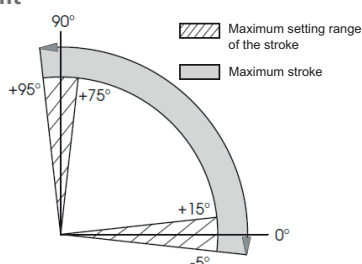

Ball valve C 200

Basic valve with hand lever

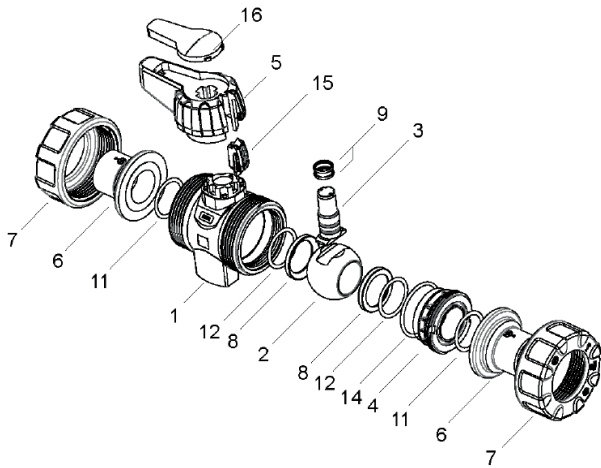

Position	Quantity	Designation
1	1	Housing
2	1	Ball
3	1	Ball pivot
4	1	Union threaded neck
5	1	Hand lever
6	2	Union end
7	2	Union nut
8	2	Ball seat
9	2	O-ring
11	2	O-ring
12	2	O-ring
14	1	O-ring
15	1	Locking slide
16	1	Hand lever inlay

Limit switch box with basic valve

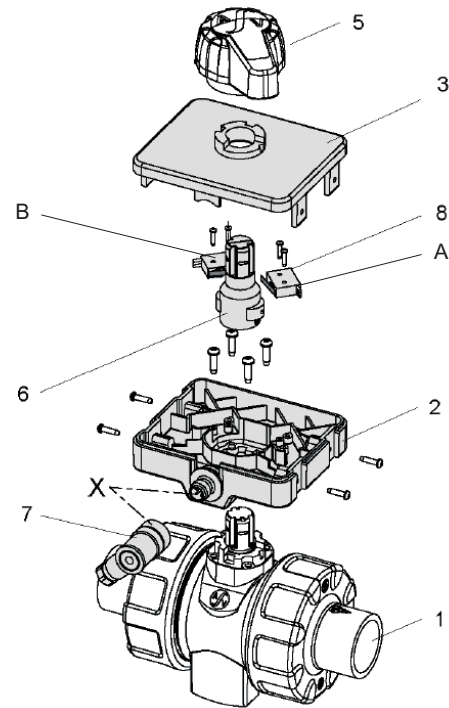

Position	Quantity	Designation
1	1	Ball valve
2	1	Mounting box, bottom section
3	1	Mounting box, top section
5	1	Hand lever
6	1	Lever extension
7	1	Plug connector X
8	2	Limit switch box (micro switch or proximity switch)

Limit switch position

A	Ball valve open
B	Ball valve closed

Ball valve C 200

Electric actuator Valpes / J&J with basic valve

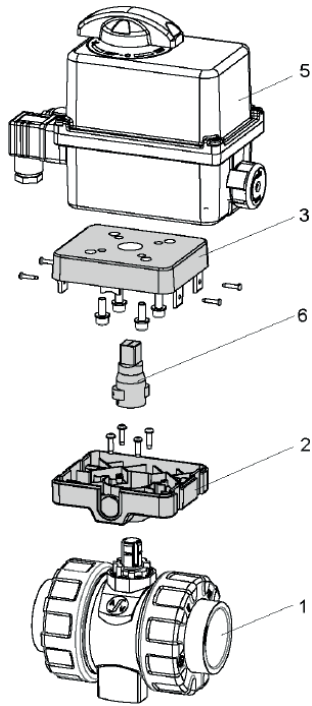

Position	Quantity	Designation
1	1	Ball valve
2	1	Mounting box, bottom section
3	1	Mounting box, top section
5	1	Electric actuator
6	1	Drive adapter

Pneumatic actuator Prisma / Air Torque with basic valve

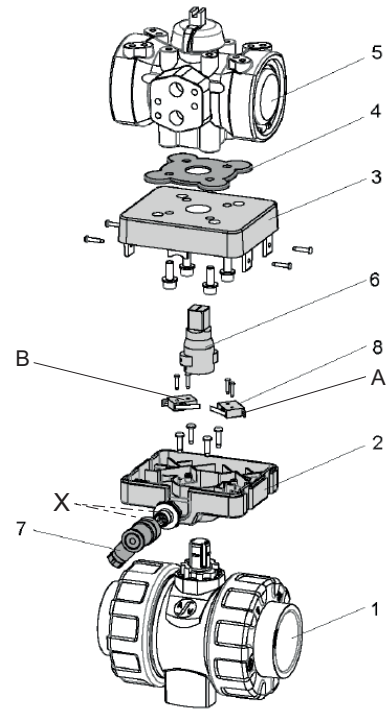

Position	Quantity	Designation
1	1	Ball valve
2	1	Mounting box, bottom section
3	1	Mounting box, top section
4	1	Sealing disk
5	1	Pneumatic actuator
6	1	Drive adapter
7	1	Plug connector X
8	2	Limit switch box (micro switch or proximity switch)

Limit switch position

A	Ball valve open
B	Ball valve closed